

TECHNICAL SPECIFICATION

Caleidoscope light module for easy installation between two Fixpoint grid ceiling channels. For module 2000x2000, 1800x1800 or 1500x1500 mm.

Housing made of powder coated sheet steel. Colour RAL9010, other colours on request.

Electronic gear for G12 HID lamps. Housing in die-cast aluminium for optimal stability and low weight.

Supplied with NL Power electronic ballast for optimal lamp life, light flow and colour performance. Very easy reflector removal for easy lamp change. Including pre-mounted Osram Powerball 35 or 70 W light source and 3,0 m earthed cable and plug.

Protection class IP 21. CE-marked.



PICTURE	DESCRIPTION	GRID SIZE	W / beam °	ART NO.
	SPACE LIGHTMODULE	2000x2000	35 W / 20°	01-001-20-201
			35 W / 64°	01-001-20-641
			70 W / 20°	01-001-20-202
			70 W / 64°	01-001-20-642
		1800x1800	35 W / 20°	01-001-18-201
			35 W / 64°	01-001-18-641
			70 W / 20°	01-001-18-202
			70 W / 64°	01-001-18-642
		1500x1500	35 W / 20°	01-001-15-201
			35 W / 64°	01-001-15-641
			70 W / 20°	01-001-15-202
			70 W / 64°	01-001-15-642

35 W SPACE

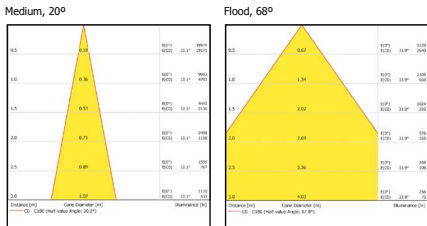

70 W SPACE

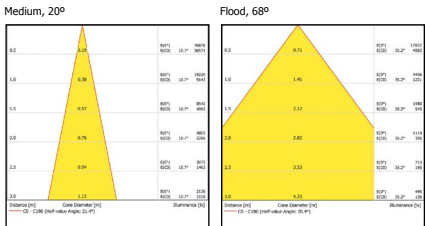

MEASUREMENTS:

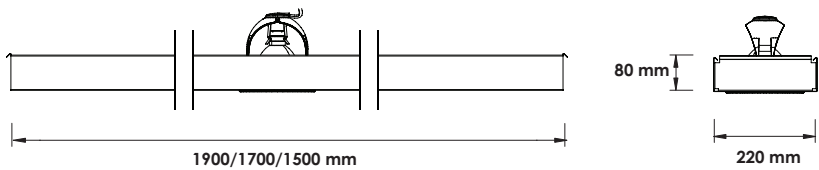
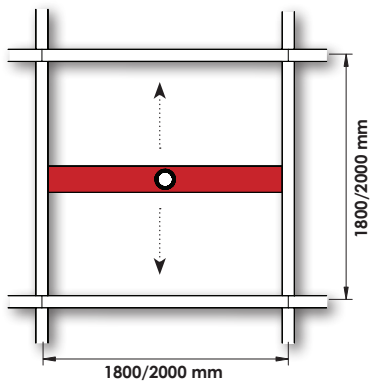

AMBER MOVE LIGHT MODULE

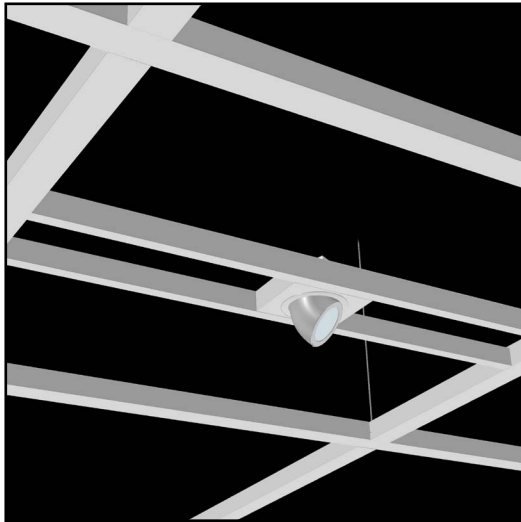

TECHNICAL SPECIFICATION

Caleidoscope light module for easy installation between two Fixpoint grid ceiling channels. For module 2000x2000, 1800x1800 or 1500x1500 mm.

Housing made of powder coated sheet steel.

Retractable and rotatable down light by. Electronic gear for G12 HID lamps. Housing in die-cast aluminium for optimal stability and low weight.

Supplied with NL Power electronic ballast for optimal lamp life, light flow and colour performance. Very easy reflector removal for easy lamp change.

Including pre-mounted Osram Powerball 35 or 70 W lightsource and 3,0 m earthed cable and plug.

Protection class IP 21. CE-marked.

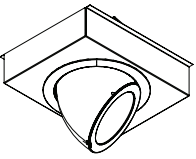
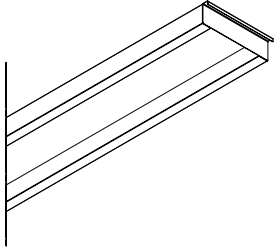

PICTURE	DESCRIPTION	Watt / Spread	ART NO.
	Amber Down Light BOX	L: 290 MM W: 227 MM H: 80 MM	07-205-61 07-205-201 07-205-681 07-205-62 07-205-202 07-205-682
	Frame for Amber For grid size 1500x1500, 1800x1800 and 2000x2000 mm.	W: 220 MM H: 80 MM	L: 1400 MM L: 1700 MM L: 1900 MM

35 W AMBER

70 W AMBER

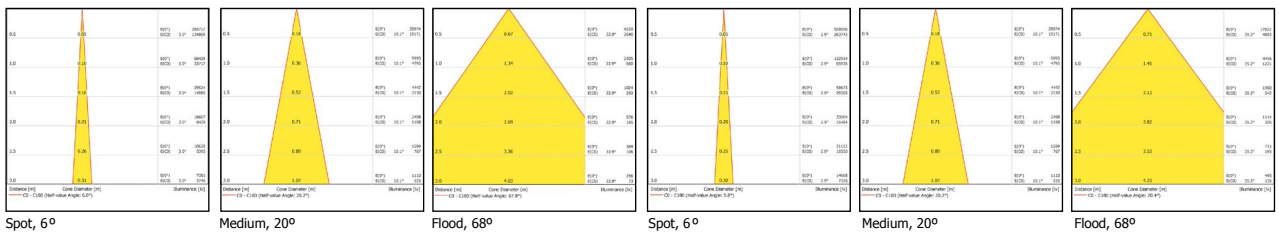

MEASUREMENTS:

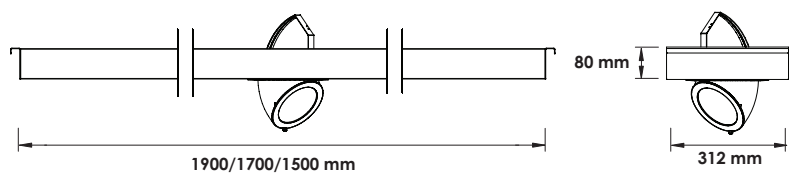
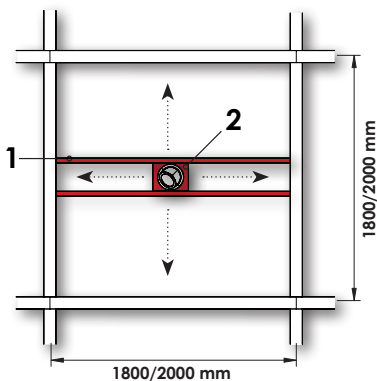

AMBER TRIANGULARE LIGHT MODULE

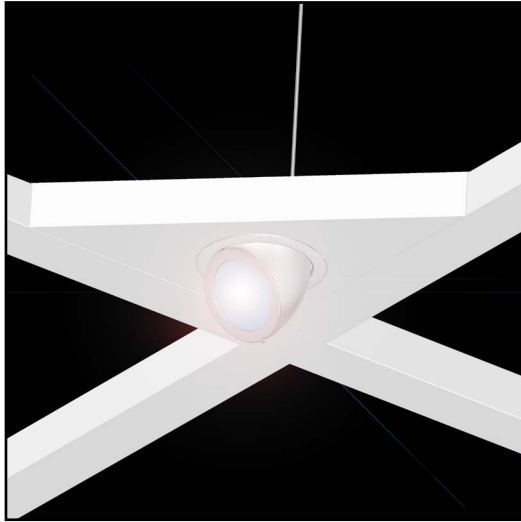

TECHNICAL SPECIFICATION

Caleidoscope triangular light module for easy installation in a corner of Fixpoint grid ceiling system. Fits all Caleidoscope modules with profile 100-80. Chassie made of powder coated steel.



Retractable and rotatable down. Electronic gear for G12 HID lamps. Housing in die-cast aluminium for optimal stability and low weight.

Supplied with NL Power electronic ballast for optimal lamp life, light flow and colour performance. Very easy reflector removal for easy lamp change.

Including pre-mounted Osram Powerball 35 or 70 W light source and 3,0 m earthed cable and plug.

Protection class IP 21. CE-marked.

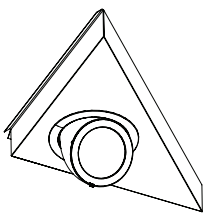
PICTURE	DESCRIPTION	DIMENSIONS	W / beam °	ART NO.
	AMBER CORNER	L: 499 MM W: 499 MM H: 80 MM	35 W / 6° 35 W / 21° 70 W / 6° 70 W / 21° 70 W / 70°	09-018-81 09-018-211 09-018-701 09-018-82 09-018-212 09-018702

35 W AMBER

70 W AMBER

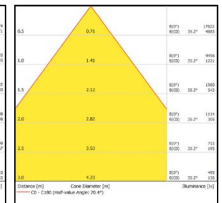
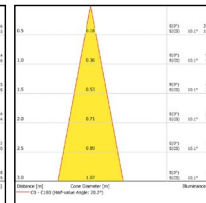
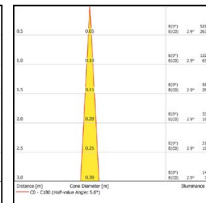
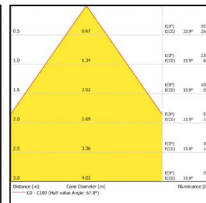
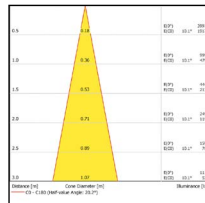
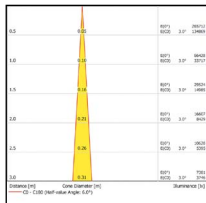

Spot, 6°

Medium, 20°

Flood, 68°

Spot, 6°

Medium, 20°

Flood, 68°

MEASUREMENTS:

